

Autonics

THIN TYPE AREA SENSOR BWP SERIES

M A N U A L



Thank you very much for selecting Autonics products.
For your safety, please read the following before using.

Caution for your safety

※Please keep these instructions and review them before using this unit.

※Please observe the cautions that follow;

Warning Serious injury may result if instructions are not followed.

Caution Product may be damaged, or injury may result if instructions are not followed.

※The following is an explanation of the symbols used in the operation manual.

Caution: Injury or danger may occur under special conditions.

Warning

- In case of using this unit with machinery(Ex: nuclear power control, medical equipment, ship, vehicle, train, airplane, combustion apparatus, safety device, crime/disaster prevention equipment, etc) which may cause damages to human life or property, it is required to install fail-safe device.
It may cause a fire, human injury or damage to property.
- This unit is not safety sensor protecting from damages of property or injury from dangerous parts of mechanical equipment, but it is the sensor detecting a normal object or irruption into the working area regardless of safety.
- Do not use it as safety equipment for the cutter or press.
- This unit does not follow any international safety standard.
Check the safety standard of the country the product is used.
- Please note that we do not take any responsibilities for the problem related to overseas' laws or <Product liability(PL)> is happened by using as follows:
① Safety equipment for protecting a hand or other parts of worker at dangerous area.
② Interlock on mechanical equipment.
③ Safety sensor on mechanical equipment for stopping it when detecting a hand or other parts of worker.
④ Using for detecting a hand or other parts of worker at dangerous area and controlling door or window.

Caution

- This unit shall not be used outdoors.
It might shorten the life cycle of the product or cause electric shock.
Use this product inside only. Do not use the product outdoors or location subject to temperatures or humidity outside.(Ex: rain, dirty, frost, sunlight, condensation, etc.)
- Do not wire this in power ON status.
It may cause electric shock.
- Use this unit in the rated specifications.
It may cause malfunction or the life cycle shorter.
- Use ground Frame Ground(F.G.) terminal when supplying power by switching power.
- Avoid using this unit where there are fluorescent light with high frequency, high speed start or signal light affecting to sensing ability.
- It may do not able to shade the light by reflecting from surface of a wall when installing it in 0.3m from wall or flat parts. Please keep <■ Installations >.
- It may cause malfunction from interference when using them closely in parallel.
Please keep <■ Installations >.
- Install an emitter and a receiver in the same direction. The emitting light is not transferred to receiver if installed in opposite direction.
- Avoid using this unit where there are severe vibration.
It may cause a fire and malfunction.
- In cleaning the unit, do not use water or an oil-based detergent.
It may cause electric shock or fire.
- Make power and output line shorten as possible, or it may cause malfunction by surge etc.

Structure

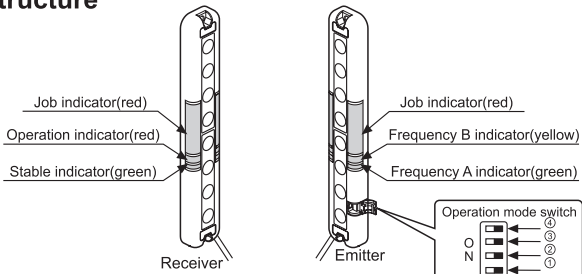

Operation mode switch

| No. | Function | Switch OFF | Switch ON |
|-----|--|---------------------|------------------------|
| ① | Selection of transmission frequency | Frequency A | Frequency B |
| ② | Light ON/Dark ON selection | Light ON operation | Dark ON operation |
| ③ | Selection light/flashing for Job indicator | Job indicator light | Job indicator flashing |
| ④ | Selection of JOB/TEST | NORMAL mode | TEST mode |

Timing diagram operation

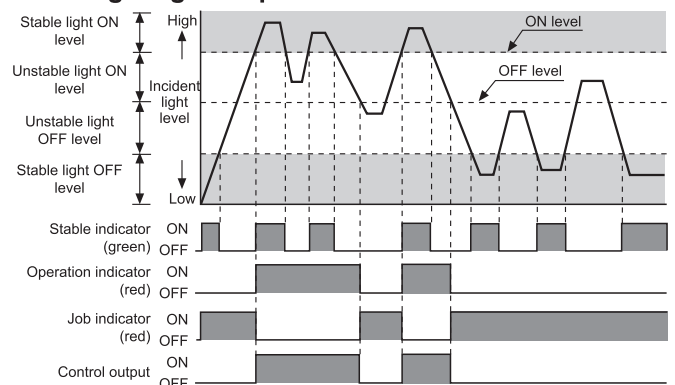

※The waveforms of operation indicator, job indicator, and control output are the state of operation for Light ON, but in case of Dark ON, it is opposite operation against Light ON mode.

Indicators display

| Item | Emitter Indicator | | Receiver Indicator | | Control output |
|------------------------------|-------------------|--------|--------------------|-----|----------------|
| | Green | Yellow | Green | Red | |
| Power ON | ● | ● | ● | ● | - |
| FREQ. A operation | ● | ● | ● | ● | - |
| FREQ. B operation | ● | ● | ● | ● | - |
| TEST | ● | ● | ● | ● | OFF |
| Stable light ON | ● | ● | ● | ● | ON |
| Unstable light ON | ● | ● | ● | ● | ON |
| Unstable light OFF | ● | ● | ● | ● | OFF |
| Stable light OFF | ● | ● | ● | ● | OFF |
| Flashing function ON | ● | ● | ● | ● | OFF |
| Synchronous line malfunction | ● | ● | ● | ● | OFF |
| Over current | ● | ● | ● | ● | OFF |

| Display classification list |
|--------------------------------------|
| ● Lighting |
| ● Light out |
| Ⓜ Flashing by 0.3sec. |
| Ⓜ Flashing simultaneously by 0.3sec. |
| Ⓜ Cross-flashing by 0.3sec. |

※The operation of 'Operation indicator(red)', 'Job indicator (red)', 'Control output' is for Light ON, in case of Dark ON, it is opposite operation against Light ON.
(In case, malfunction of synchronous line and over current, control output is OFF regardless of the mode.)

※Las especificaciones anteriores pueden cambiar sin previo aviso o unos modelos pueden suspenderse.

Ordering information

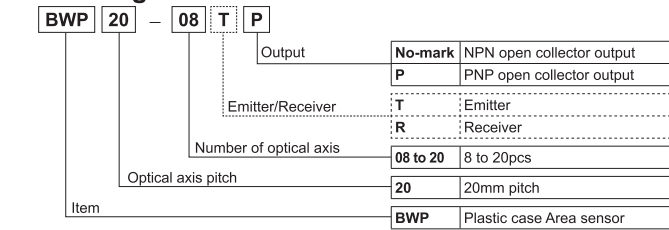

※ This information is intended for product management. (no need to refer when selecting a model)

Specifications

| Model | NPN open collector output | BWP20-08 | BWP20-12 | BWP20-16 | BWP20-20 |
|--------------------------|---|-----------------------------|-----------------------------|-----------------------------|-----------|
| | PNP open collector output | BWP20-08P | BWP20-12P | BWP20-16P | BWP20-20P |
| Sensing type | Transmitte beam type | | | | |
| Sensing distance | 0.1 to 5m | | | | |
| Sensing target | Opaque materials of min. Ø30mm | | | | |
| Optical axis pitch | 20mm | | | | |
| Number of optical axis | 8EA | 12EA | 16EA | 20EA | |
| Sensing width | 140mm | 220mm | 300mm | 380mm | |
| Power supply | 12-24VDC ±10%(ripple P-P: max. 10%) | | | | |
| Protection circuit | Built-in | | | | |
| Current consumption | Emitter: Max. 80mA, Receiver: Max. 80mA | | | | |
| Control output | NPN or PNP open collector output • Load voltage: Max. 30VDC • Load current: Max. 150mA • Residual voltage - NPN: Max. 1V, PNP : Max. 2.5V | | | | |
| Operation mode | Switching of Light ON/Dark ON by switch | | | | |
| Short-circuit protection | Built-in | | | | |
| Response time | Max. 6ms(frequency B selection is max. 7ms) | | | | |
| Light source | Infrared LED(850nm modulated) | | | | |
| Synchronization type | Timing method by synchronous line | | | | |
| Interference protection | Interference protection by transmission frequency selection | | | | |
| Environment | Sunlight: Max. 10,000lx (received light side illumination) Ambient temperature: -10 to +55°C, storage: -20 to +60°C Ambient humidity: 35 to 85%RH, storage: 35 to 85%RH | | | | |
| Noise resistance | ±240V the square wave noise(pulse width 1µs) by the noise simulator | | | | |
| Dielectric strength | 1,000VAC 50/60Hz for 1minute | | | | |
| Insulation resistance | Min. 20MΩ(at 500VDC megger) | | | | |
| Vibration | 1.5mm amplitude at frequency of 10 to 55Hz in each of X, Y, Z directions for 2 hours | | | | |
| Shock | 500m/s ² (50G) in each of X, Y, Z directions for 3 times | | | | |
| Protection | IP40(IEC standard) | | | | |
| Material | Case: PC/ABS, Sensing part: PMMA | | | | |
| Cable | Ø3.5mm, 4-wire, Length: 3m(emitter: Ø3.5mm, 4-wire, length: 3m) (AWG24, core diameter: 0.08mm, number of cores: 40, insulator diameter: Ø1mm) | | | | |
| Approval | CE | | | | |
| Weight ^{※1} | Approx. 480g (approx. 280g) | Approx. 520g (approx. 320g) | Approx. 620g (approx. 360g) | Approx. 680g (approx. 430g) | |

※1: The weight is with packaging and the weight in parentheses is only unit weight.
※The temperature or humidity mentioned in Environment indicates a non freezing or condensation environment.

Dimensions

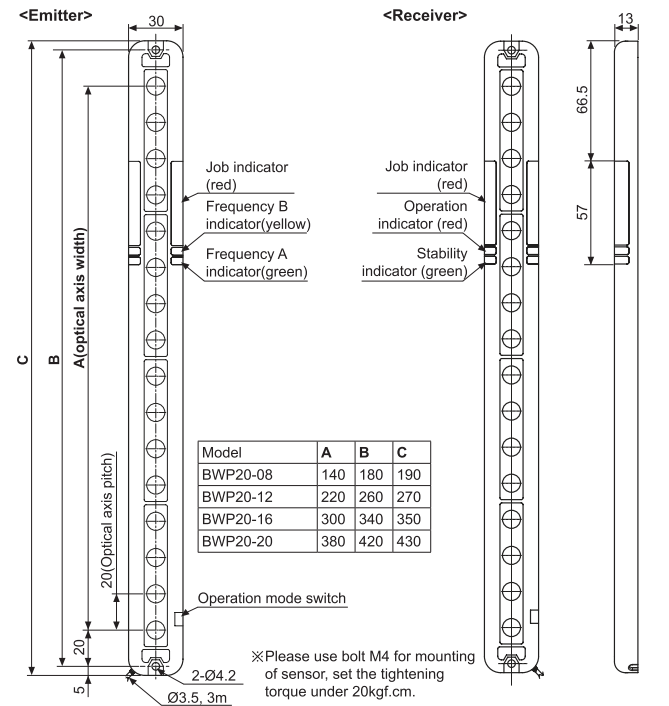

Bracket: sold separately

Flat bracket(BK-BWP-ST)

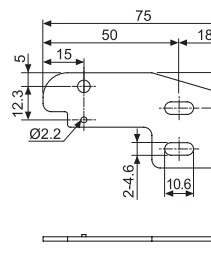

L-shaped bracket(BK-BWP-L)

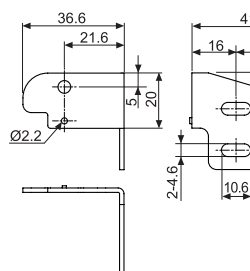

Protection bracket(BK-BWP-P)

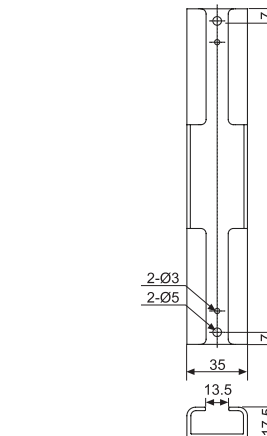

Input/Output circuit and connection diagram

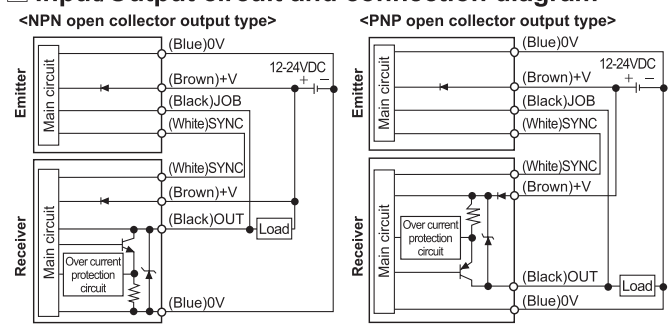

※If the receiver OUT(Black) line and the emitter JOB(Black) line are not connected each other, the job indicator of the emitter is not operated and maintains the light status.

Installations

○ For direction of installation
Emitter and receiver should be installed in same up/down direction.

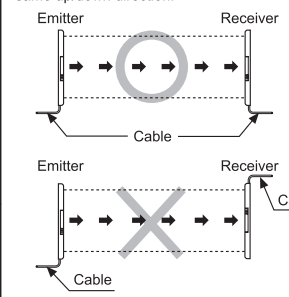

○ For reflection from the surface of wall and flat
When installing it as below, the light reflected from the surface of wall and flat is not shaded. Please check whether it operates normally or not with a sensing target before using. (interval distance: min. 0.3m)

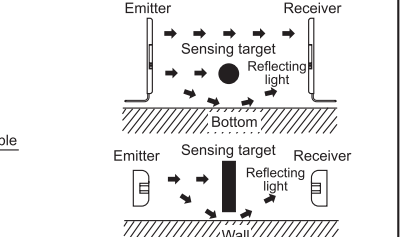

○ For protection of interference
It may cause interference when installing more than 2 sets of the sensor. In order to avoid the interference of the sensor, please install as following figures and use the interference protection function.

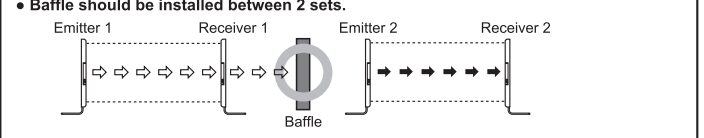
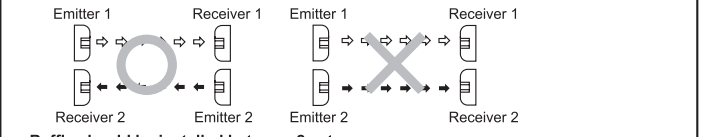
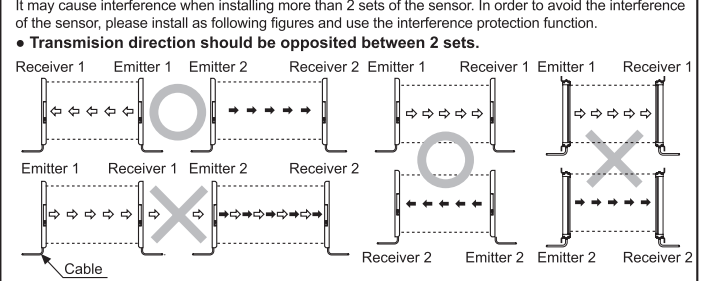

| Sensing distance (L) | Installation allowable distance (D) |
|----------------------|-------------------------------------|
| 0.1 to 1m | Min. 0.2m |
| Min. 1m | Min. 0.3m |

※It may be a little different based on installation environment.

Functions

○ TEST(stop transmission function)
When selecting TEST mode, emit is stopped and green&yellow LED of emitter flashes. It is available to check whether sensor operates properly with stopping the transmission in TEST mode. It is changed to light OFF status when emit the transmission is stopped, control output is OFF in Light ON mode and ON in Dark ON mode.

Control output pulse by TEST input

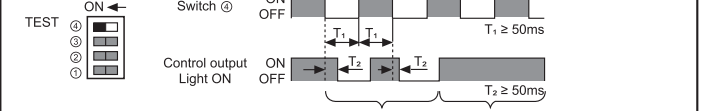

Interference protection

In case of using 2EA of sensor in serial or parallel in order to extend sensing width, it may cause sensing error because of light interference. This function is operating a sensor in transmission frequency A and another sensor in transmission frequency B to avoid these sensing errors by the light interference.

Light ON/Dark ON mode

The control output is ON when it is light ON in Light ON and the control output is ON when it is light OFF in Dark ON. It is available to select with user's preference.

Switching of Lighting/Flashing of Job indicator

Job indicator is lighting or flashing to make out work sensing operation more easily.

Troubleshooting

| Malfunction | Cause | Troubleshooting |
|--|---|--|
| Non-operation | Power supply Cable incorrect connection or disconnection | Supply rated power. Check the wiring. |
| Non-operation in sometimes | Rated connection failure Pollution by dirt of sensor cover Cable connection failure | Use it within rated sensing distance. Remove dirt by soft brush or cloth. Check the assembled part of the cable. |
| Control output is OFF even though there is not a target object | Out of rated sensing distance There is an obstacle to cut off the light emitted between emitter and receiver There is a strong electric wave or noise generator such as motor, electric generator, high voltage line etc. | Use it within rated sensing distance. Remove the obstacle. Put away the strong electric wave or noise generator. |
| LED displays for synchronous line malfunction | Synchronous line incorrect connection or disconnection Break of synchronous circuit of emitter or receiver | Check the wiring. Contact our company. |
| LED displays for over current | Control output line is shorten Over load | Check the wiring. Check the rated load capacity. |

Caution for using

- Please make the interval enough between 2 sets or exchange the positions of emitter and receiver in order to remove interference as occurring interference by the emitter of another set when using emitter/receiver more than 2 sets closely.
 - Please install this sensor at proper height(min. approx. 0.3m) from flat part because malfunction may be caused due to certain amount of light received by light reflected when installing it close to flat part.
 - Avoid using this unit where there are fluorescent light with high frequency, high speed start or signal light affecting to sensing ability.
 - Please use a single conduit or separated wiring as it may cause malfunction or mechanical problem when installing the wiring of the sensor with high voltage lines.
 - Avoid using this unit where there are places with corrosive gas or dust, or it may cause malfunction.
 - Please make power and output line shorten as possible, or it may cause malfunction by surges etc.
 - Please clean the sensor cover with dry cloth when it is stained by dirt etc., but do not use organic materials such as thinners.
 - When using switching mode power supply as the source of supplying power, Frame Ground (F.G.) terminal shall be grounded and a condenser for removing noise shall be installed between 0V and F.G. terminal.
 - Installation environment
①It shall be used indoor ②Altitude max. 2,000m ③Pollution degree 2 ④Installation category II
- ※It may cause malfunction if above instructions are not followed.

Major products

| | |
|---|---|
| <ul style="list-style-type: none"> Photoelectric sensors Fiber optic sensors Door sensors Area sensors Proximity sensors Pressure sensors Rotary encoders Connector/sockets Switching mode power supplies Control switches/Lamps/Buzzers I/O Terminal Blocks & Cables Stepper motors/drivers/motion controllers Graphic/Logic panels Field network devices Laser marking system(Fiber, CO₂, Nd:YAG) Laser welding/soldering system | <ul style="list-style-type: none"> Temperature controllers Temperature/Humidity transducers SSR/Power controllers Counters Timers Panel meters Tachometer/Pulse(Rate)meters Display units Sensor controllers |
|---|---|

Autonics Corporation
http://www.autonics.com

Satisfiable Partner For Factory Automation

HEAD QUARTERS:
16, Bansong-ro 513beon-gil, Haeundae-gu, Busan, Korea

OVERSEA SALES:
#402-404, Bucheon Techno Park, 655, Pyeongcheon-ro, Worn-gu, Bucheon, Gyeonggi-do, Korea
TEL: 82-32-610-2730 / FAX: 82-32-329-0728

E-mail: sales@autonics.com